

UNITILE USF 2000 EB - PVC EDGE SUPPORT RIGID GRID (ESRG) SYSTEM

PANEL ILLUSTRATION

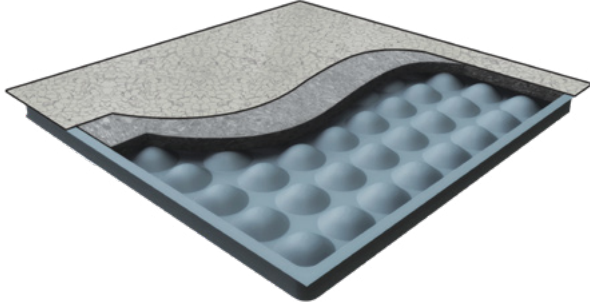

Category	2 mm PVC - Edge Beeding, ESRG System
Panel size	600 x 600 mm
Core Material	Cement
Panel Core Thickness	35 mm
Panel Weight	21.400 kgs
Weight of System	67kgs / m2 for FFH 300mm (varies with height)
Overall Floor Height	65 mm - 2000 mm

FEATURE BENEFITS

- Enhanced load-bearing capacity.
- Higher footprint area on pedestal head leading to enhanced stability & improved load carrying capacity.
- No overlapping of panels.
- Edge Support Design reduces the risk of damage to the panel edges during exposures to rolling and impact loads at site.

PRODUCT STRUCTURAL PERFORMANCE

Conforming to Master Specs 10270 / 096900 (USA) CISCA A/F, 'Recommended Test Procedures for Access Floors'

Concentrated Load (Point Load) As per CISCA 2007	907 kgs (2000 lbf)
Uniformly Distributed Load (UDL) As per CISCA 2007	3600 kg/m2
Ultimate Concentrated Load (As per CISCA 2007)	1814 kgs (4000 lbf)
Rolling Loads (As per CISCA 2007)	425 kgs (937 lbf)
Stringer Loads (As per CISCA 2007)	102 kgs (225 lbf)
Pedestal Axial Load Test (As per CISCA 2007)	22 kN
Pedestal Over Turning Moment Test (As per CISCA 2007)	113 N x Meters

SYSTEM DESCRIPTION

USF 2000 Access floor panels are uniquely designed with hemispherical reinforcing pockets on the underside. It ensures structural strength, ultimate durability and acoustic performance.

The pedestal assembly shall provide easy adjustment of leveling and accurately align panels for a maximum ± 25 mm in the vertical direction. The Pedestal head assembly shall consist of embossed head mechanically riveted to a rolled formed stud and 2 check nuts for level adjustment and arresting vertical movement. The pedestal head shall consist of an anti-vibration PVC cap with inbuilt isolating spacers for Panel and stringer location.

The stringer shall be continuous box type, for strength, lateral stability, and for enhanced rolling loads performance and to support the panels on all four sides for alignment without leaving any gap at the pedestal head preventing air leakage.

PANEL CONSTRUCTION

USF 2000 Access Floor panel is of size 600 x 600 mm, it is all steel welded construction with an enclosed bottom pan of hemispherical cones and the top plain sheet is fuse-welded at 144 locations to form a panel.

The hollow panels are pretreated and coated with electrostatically deposited powder coated 60 - 80 micron thick on all the exposed sides of the panel. The hollow core of the panel is injected with a light weight, fire retardant, noncombustible cementitious compound at high pressure to ensure support of not less than 90% of the top surface area of the panel.

The panel is then laminated with floor grade Antistatic Laminate on a semi-automated lamination line to ensure maximum bonding to the steel surface. The edges of the laminated are protected with conductive PVC edge trim 5 mm wide on all sides. This edge trim is mechanically locked and sealed in place to avoid detachment.

APPLICATIONS

- Data Center
- Computer Room
- Server / Hub Room
- Switch Room
- Communication Room
- Control room

FACTORY BONDED FINISHES

- PVC

UNITILE USF 2000 EB – PVC EDGE SUPPORT RIGID GRID (ESRG) SYSTEM

OTHER STRUCTURAL PARAMETERS

Soft body impact	Tested as per (T12.00) of MOB PF2 PS Standards
Hard body impact	Tested as per (T13.00) of MOB PF2 PS Standards
Fire rating	Class O & Class 1, as per BS 476 Part 6 & 7, And also ASTM E84 1998 (Flammability) and ASTM E136 (Combustibility)

INSTALLATION TOLERANCE

Overall level before application of any load	±1.5 mm over any 5.00 sq. mt. ±6 mm over any size of basic space
Panel Level	±0.75 mm before the application of any load
Panel Interchangeability installation and removal	Interchangeable (except for field cut panels) & replaceable in any of the four directions at 900 increments

ELECTRICAL RESISTIVITY

As per ASTM F150 / special applications tested at 500 volts:

Conductive range	$2.5 \times 10^4 - 1 \times 10^6$ Ohms (surface to ground)
------------------	--

FABRICATION TOLERANCE

Floor Panel Flatness	±0.75 mm in any direction
Floor Panel Width or Length from specified size	±0.50 mm
Floor Panel Squareness	±0.38 mm

SPECIAL APPLICATIONS

Bridging Sections	Where obstructions prevent the use of pedestals
Ramp Pedestals	Pivot head pedestal to support angled ramp panels

Note:

- The above mentioned loading parameters are derived & defined on the basis of the tests performed by the manufacturer based on the guidelines provided by the specified standards or as per manufacturer's recommendations.
- Manufacturer has all the rights to change or revise the specifications as and when applicable or required without the prior notice.

PANEL CONSTRUCTION

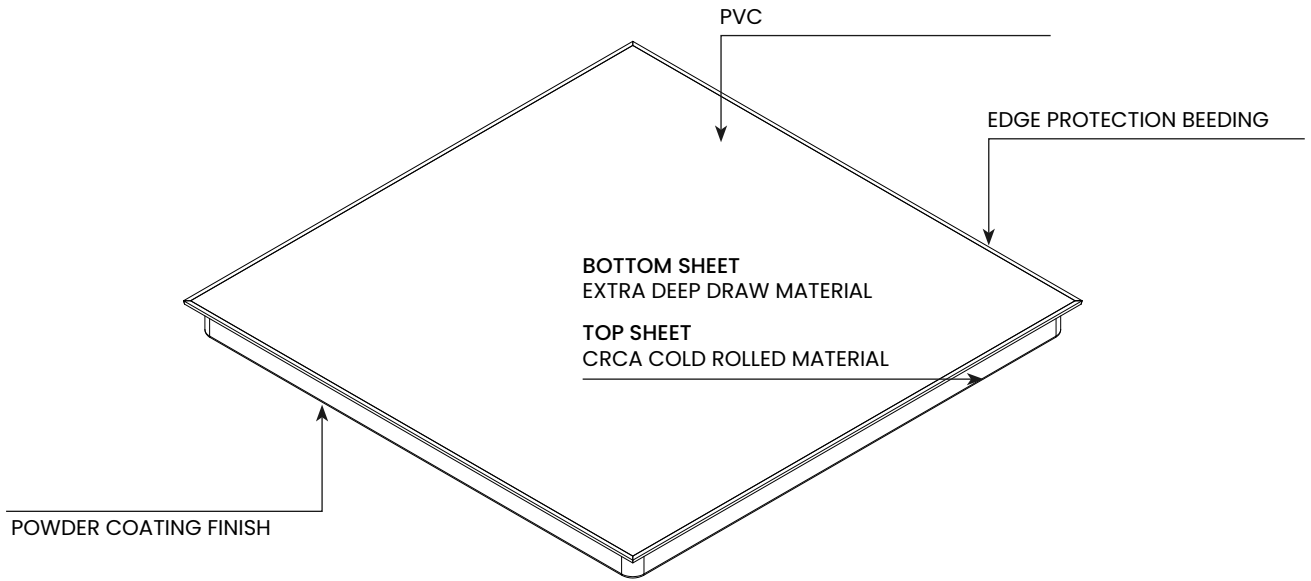

PANEL BOTTOM VIEW

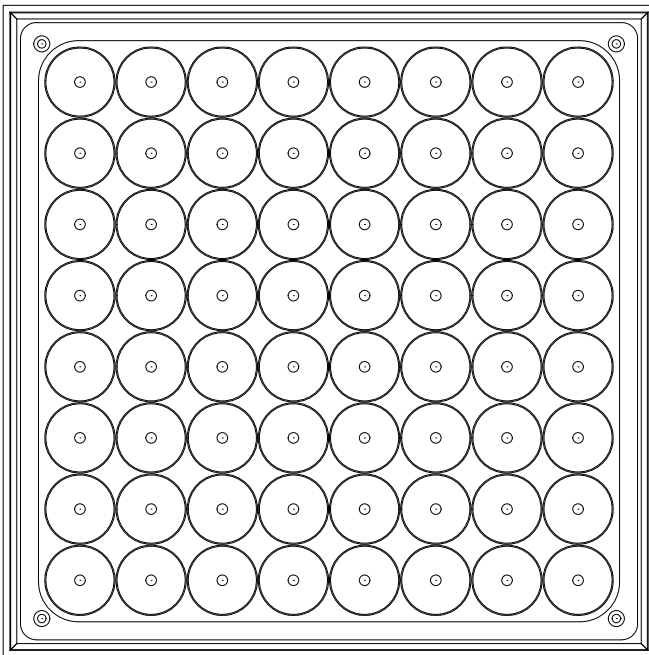

UNDERSTRUCTURE

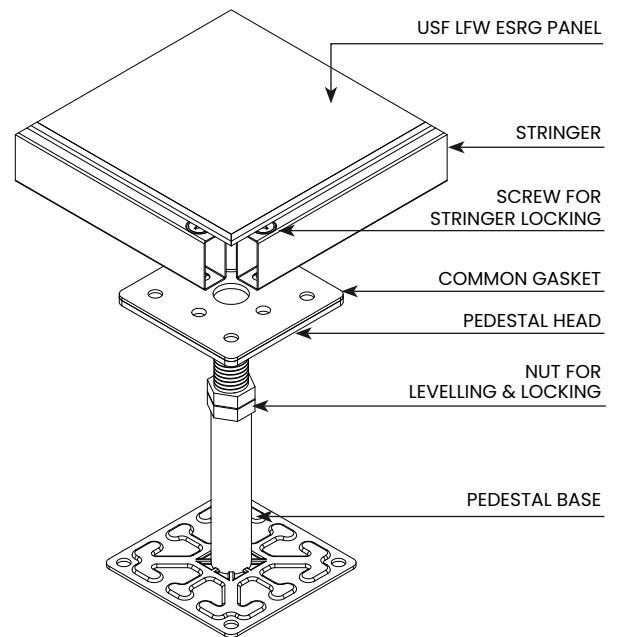

SECTION VIEW

