

**U-Flex Extreme**

Built for the **Load**.  
Ready for the **Future**.



**ENGINEERED STRUCTURAL  
CEILING SYSTEM**

Overhead Infrastructure Solution for  
Futureproofing Data Centers & Critical  
Applications

# System Grid Overview

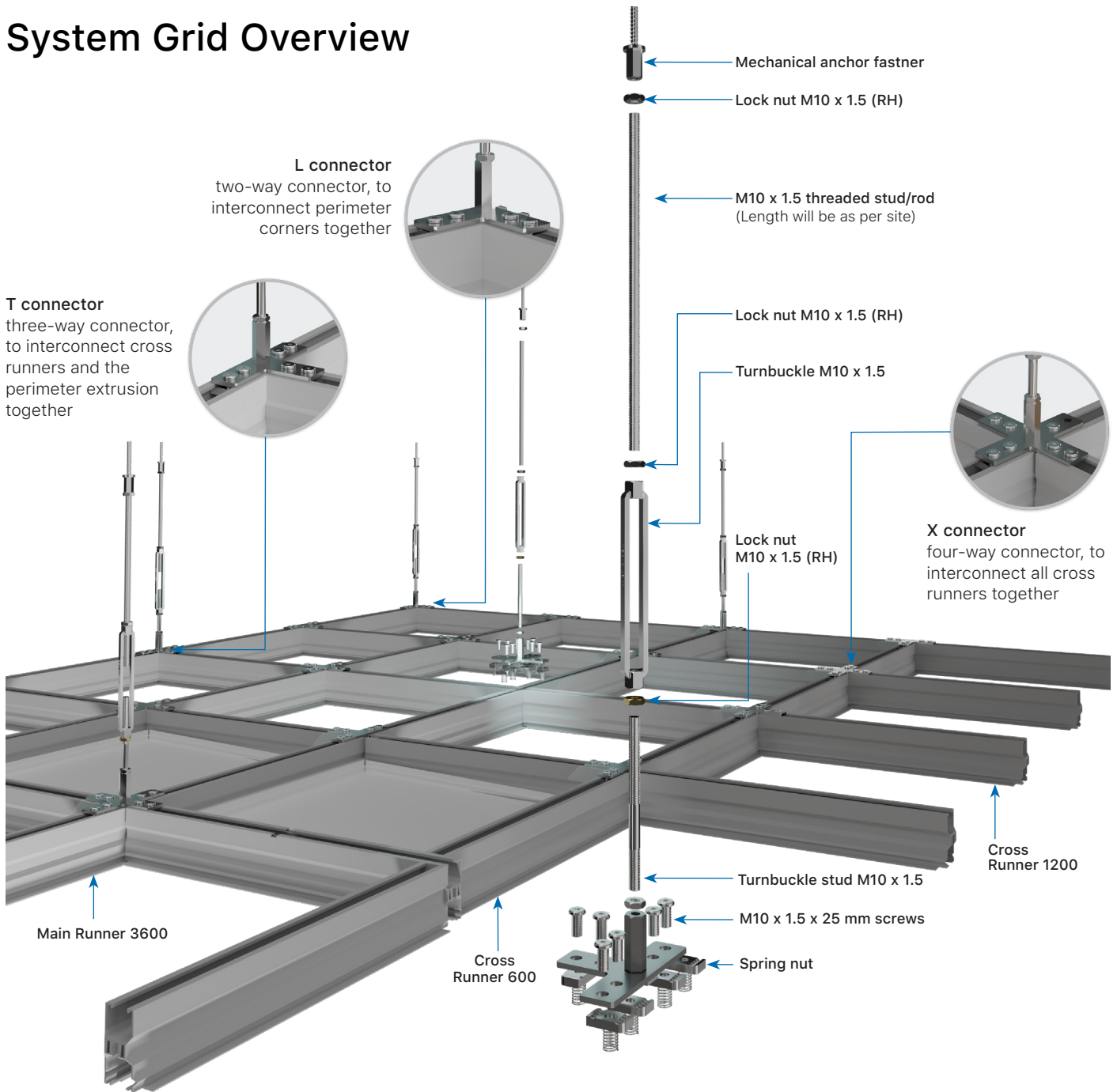



## Performance Summary

Parameters	Values
Maximum safe working point load*	4.90kN / 500kg
Maximum safe uniform load*	6.81kN/m <sup>2</sup> / 695 kg/m <sup>2</sup>
Required torque for top slot	7Nm
Factor of Safety	2
Top & Bottom slot	Standardized strut channel nut connectors

\*Based on 1200mm x 1200mm hanger configuration.

The bottom side of the structural grid has a universal channel slot, designed to fit standard strut channel nuts. Refer to the table above for load performance details on the grid and connections.

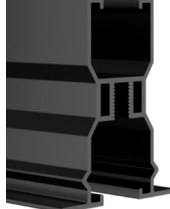
# Grid Options

<p><b>System Layout</b></p> <ul style="list-style-type: none"> <li>600 x 600mm</li> <li>600 x 1200mm</li> <li>1200 x 1200mm</li> </ul>	<p><b>Center Spacing</b></p> <p>Customized grid size to accommodate project/site requirements</p>	<p><b>Available Finish</b></p> <div style="display: flex; justify-content: space-around; align-items: flex-start;"> <div style="text-align: center;">  <p>Silver Anodized Matt</p> </div> <div style="text-align: center;">  <p>Black Anodized</p> </div> <div style="text-align: center;">  <p>RAL 9003</p> </div> </div>
--	---	--

## Key Design Features

- Designed as an attachment platform or suspension system for containment barriers, partitions, and ceiling suspended service equipment in the room void.
- Continuous C slot acts as a support structure for all overhead services and fixtures, enabling easy installation of firefighting systems, LV tray and HV tray (busbars, sensors and detectors, lights, CCTV camera, and other such utilities at any location). (Compatible with M8, M10 and M12 stud).
- Easy access to the overhead plenum with removable ceiling panels without compromising the structural integrity of the structural grid and the services supported below.
- The entire grid panel is accessible from the bottom for seamless inspection, maintenance and layout changes.
- Grid point load of 4.90 kN / 500 kgs, based on building connection spacing of 1200mm at the suspension location.

**\*Note:**

1. Non-standard grid size can be considered on request based on project/customer requirements. Please contact our sales team to know more.
2. The data has been independently verified and certified by an accredited third-party certification body.

## Runner Specification

All 600mm cross runners have CNC milled ends which allow the grid to overlap on the perpendicular supporting runners to ensure a snug fit and enhanced load-carrying capacity. (Cut Length 568.5mm)

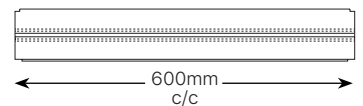

All 1200mm cross runners and main runners come with inbuilt notches at every 600mm on the center for proper alignment of the grid and accurate spacing of the connectors. (Cut Length 1168.5mm)

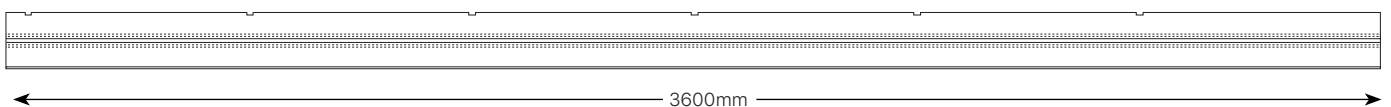
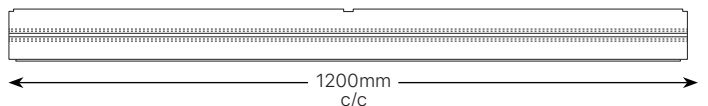

All 3600mm main runners are notched every 600mm on the center for proper alignment and spacing of the connectors. (Cut Length 3600mm)

## Extrusion Profiles

(All dimensions in mm)

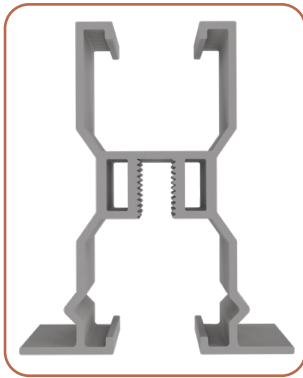

### Main Extrusion

**3600/1200/600**  
70.60 (W) X 85.60 (H)

**MOC:** Special grade structural aluminum alloy extrusion.

**Top:** Continuous C slot for spring nut locking.

**Bottom:** Continuous C Slot for accommodating-M8/M10/M12 nut locking as per requirement with additional M10 threaded portion

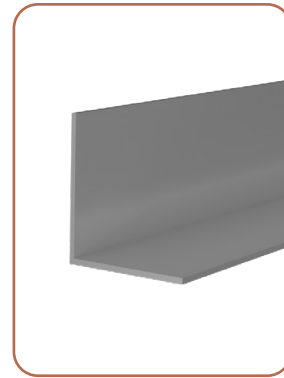

### L Wall Angle

For perimeter support

## Connector Specifications

(All dimensions in mm)



### X Connector

**Product code 122539**  
144 (L) x 144 (W) x 54 (H) x 5 (T)

Manufactured from high-strength, corrosion-resistant mild steel (M.S.) with a zinc electroplated finish.

**Application:** Used to interlock all cross tees, providing a rigid and stable connection.



### T Connector

**Product code 122540**  
144 (W) x 86.5 (L) x 54 (H) x 5 (T)

Fabricated using high-strength, corrosion-resistant M.S. with a zinc electroplated finish.

**Application:** Installed along walls, columns, or other space interfaces to support perimeter conditions. These connectors are designed for on-site customization during installation.



### L Connector

**Product code 122541**  
88.5 (W) x 88.5 (L) x 54 (H) x 5 (T)

Manufactured from high-strength, corrosion-resistant M.S. with a zinc electroplated finish.

**Application:** Used to interlock perimeter extrusion corners, ensuring secure and aligned joints at angular intersections.

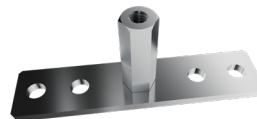

### I Connector

**Product code 122542**  
144 (W) x 33 (L) x 54 (H) x 5 (T)

Made from high-strength, corrosion-resistant M.S. with a zinc electroplated finish.

**Application:** Designed to interlock the ends of main beams, ensuring structural continuity.

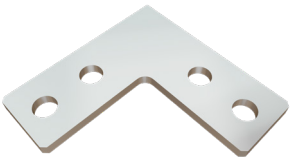
**X flat bracket****Product code 122545****Material:** Mild Steel (M.S.) with corrosion-resistant finish.**Application:** Used for four-way junctions in ceiling or partition assemblies, offering flat reinforcement at cross-point intersections.**T flat bracket****Product code 122547****Material:** Mild Steel (M.S.) with corrosion-resistant properties.**Application:** Used in partition systems or ceiling installations to provide flat junction support, typically where a 'T' configuration is required.**L flat bracket****Product code 122548****Material:** Mild Steel (M.S.) with corrosion-resistant finish.**Application:** Typically used in partition or ceiling systems for corner junctions, offering flat surface support at 90° intersections.**I flat bracket****Product code 122550****Material:** Mild Steel (M.S.) with corrosion-resistant finish.**Application:** Designed for inline reinforcement of beams or members; provides flat joining support in linear applications.

## Other Component Specifications (All dimensions in mm)

**Turnbuckle****Product code 112359**

M10 x 1.5 X 180 (L)

Made from zinc-plated cast steel alloy, the turnbuckle serves as a connector between threaded rods to provide structural support to the grid.

**Threaded Rod****Product code 112356**

M10 x 1.5 (Length as per site)

Zinc electroplated threaded rod used for ceiling suspension. One end is fixed to a structural surface (e.g., concrete or steel), while the other connects to the ceiling frame.

**Turnbuckle Stud****Product code 112358**

Zinc electroplated turnbuckle stud used where additional length and rigidity are required to securely fasten the turnbuckle and the runner together.

**Mechanical Anchor Fastener****Product code 112546**

7.5 (D) x 55 (L) with M10 x 1.5 boss for suspension

Steel alloy zinc-plated mechanical anchor fastener designed to fix threaded rods in suspended ceilings to concrete structures.

**Beam Clamp****Product code 112547**

M10 x 1.5

Zinc-plated cast steel alloy beam clamp used for steel-to-steel connections between structural beams. Eliminates the need for drilling, welding, or additional fabrication.

**Ultra Low Head Allen Socket Screws****Product code 113133**

M10 x 1.5 x 25 (L)

Allen socket screws used to fix connectors and services within the structural system.



LH Nut



RH Nut

**Lock Nut****Product code: LH - 112669****RH - 112545**

M10 x 1.5

Zinc electroplated lock nut used to fasten and secure the turnbuckle to the structural grid, ensuring a stable assembly.

# Suspension & Assembly Overview

With U-Flex engineered structural grids, rapid installation can be achieved while maintaining substantial cost savings over more traditional & cumbersome structural ceiling systems.

The grid is suspended from the building structure above using a threaded rod which connects to the turnbuckle for height adjustments according to the site/user requirements. Notches are located at fixed intervals on the main runner for accurate location of connectors and alignment of the grid.

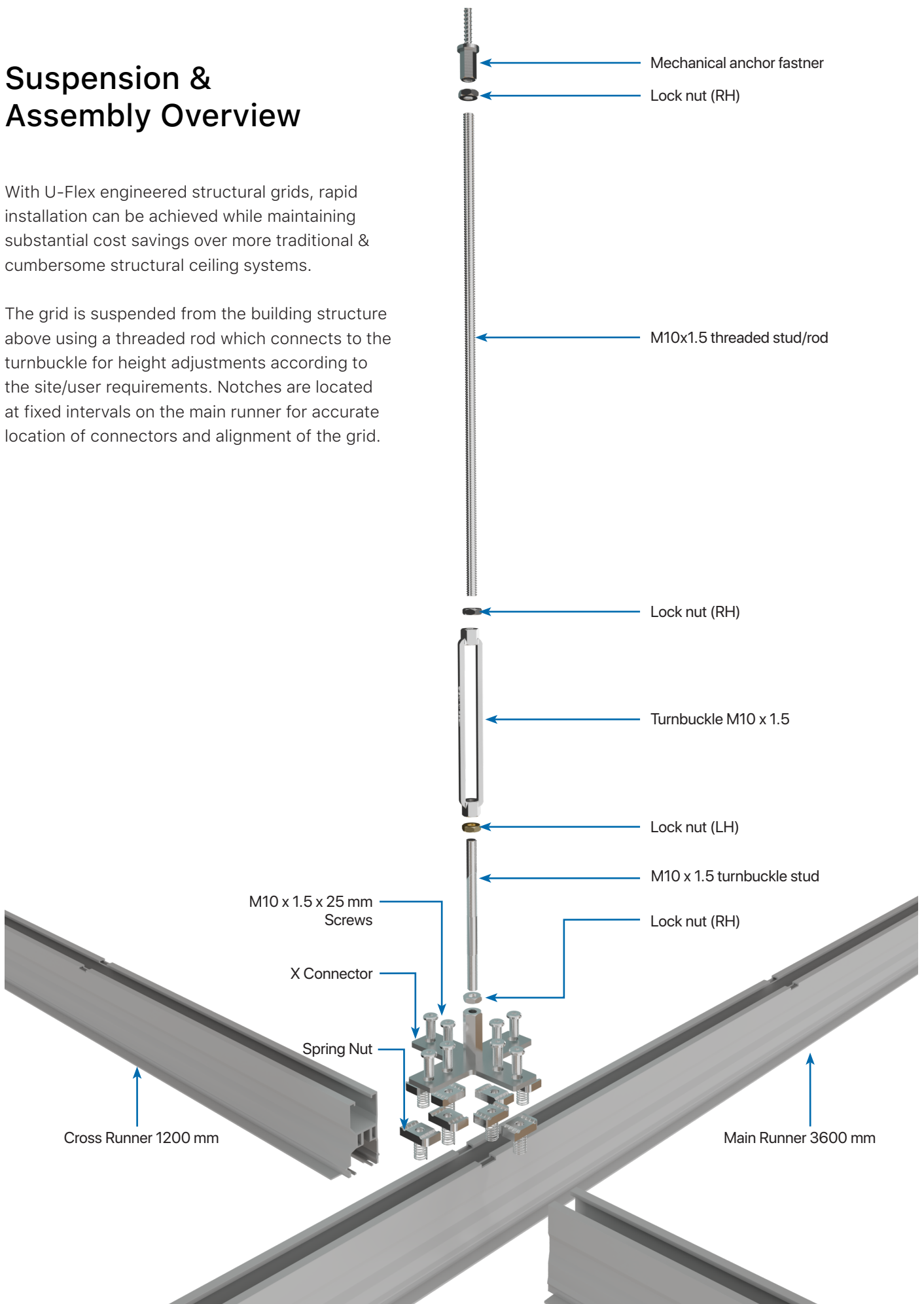

Mechanical anchor fastener

Lock nut (RH)

M10x1.5 threaded stud/rod

Lock nut (RH)

Turnbuckle M10 x 1.5

Lock nut (LH)

M10 x 1.5 turnbuckle stud

Lock nut (RH)

M10 x 1.5 x 25 mm  
Screws

X Connector

Spring Nut

Cross Runner 1200 mm

Main Runner 3600 mm

# Seismic Support

The intent of the seismic design is to minimize risk and reduce damage to the structure. The following seismic design solutions are available.

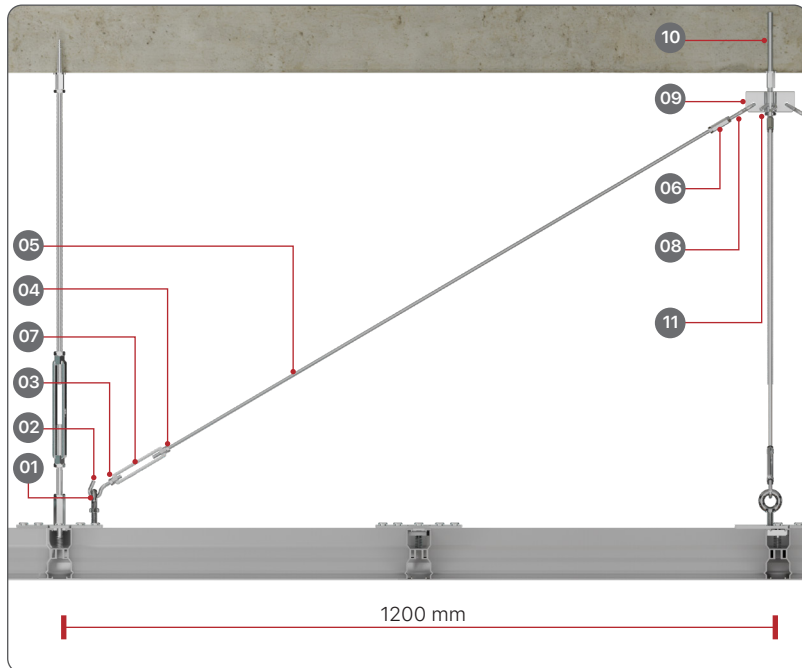

- 01 M10 Eye Bolt
- 02 M6 LH Hook For Connection with Eye Bolt
- 03 M6 LH Check Nut
- 04 M6 RH Check Nut
- 05 M6 Threaded Rod (Length To Suit Site)
- 06 M6 RH Coupler 30 mm Long
- 07 M6 LH/RH Turnbuckle
- 08 M6 RH Hook For Connection Bracket
- 09 Steel Bracket 4 Way
- 10 Threaded Concrete Anchor (Make: Rawlplug) M10 X 40
- 11 M10 RH Check Nut

## Support Components

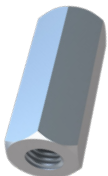

**Hexagonal Boss**  
Product code: 114267



**Eye Bolt**  
Product code: 112884  
M10 x 1.50 x 25.00 mm



**Threaded Turn Buckle**  
Product code: 114265



**Long Screw Hook**  
Product code:  
LH: 114261 RH: 114262  
M6 x 1.0 x 75 mm

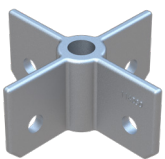

**Seismic Support Bracket**  
Product code: 114260  
(80 x 80 x 35 x ø11)

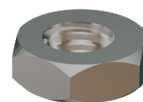

**Check Nut**  
Product code:  
RH: 114263 LH: 114264  
M6 x 1.00 mm



**Threaded Rod**  
Product code: 114266  
(M6 x 1.00 RH)

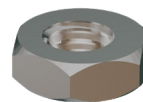

**Lock Nut**  
Product code: 112545  
M10 X 1.50 mm

# Strength in Every Span

Precision aluminium sections designed for extreme performance

## HEAVY DUTY 2.00 MM THICK

### Usage & Impact

- Core structural strength
- Long span support with minimal sag
- Suitable for both industrial and commercial suspended ceiling setups

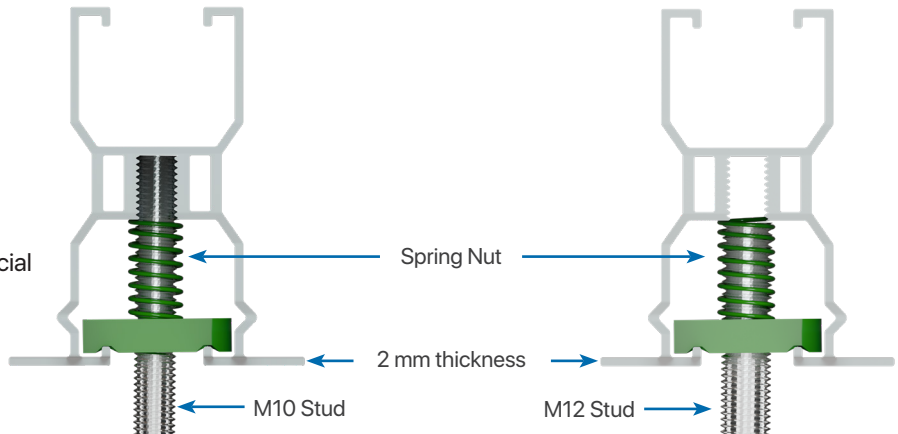

# Grid Spacing & Tile Sizing

Grid spacing can be adjusted to fit standard 600 x 1200 mm nominal tile size, depending on customer's preference. Refer to the table below to determine tile size requirements.

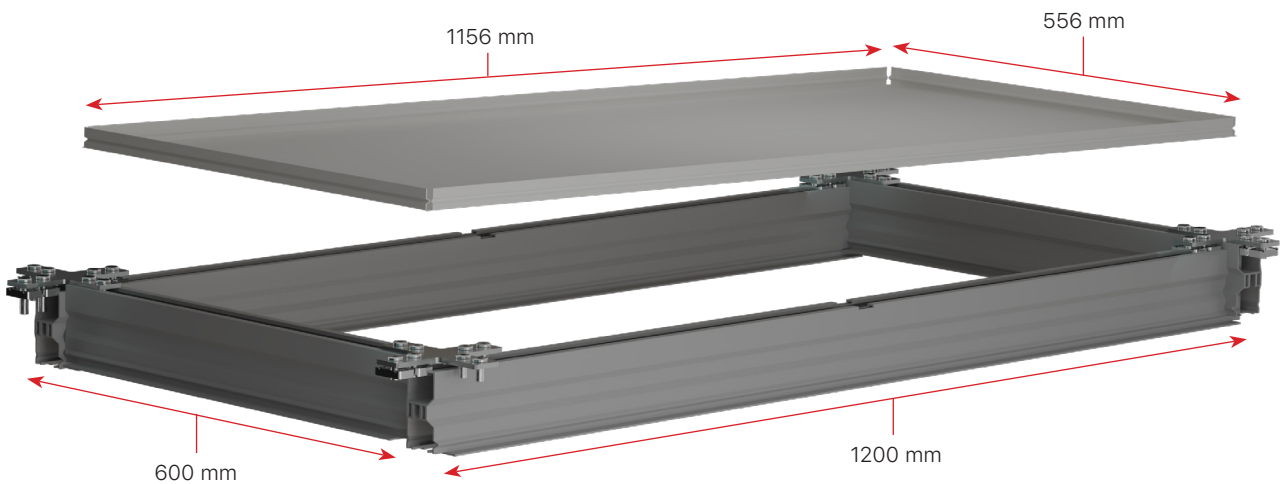

Note: Image for reference only. For specific data centre air pressures, contact the Unitile technical team.

# Snap-Fit Ceiling Panels

Engineered for rapid installation and easy removal. Snap-fit panels offer a flush, uniform finish minimizing downtime and enabling quick maintenance while delivering a clean, sophisticated ceiling aesthetic.

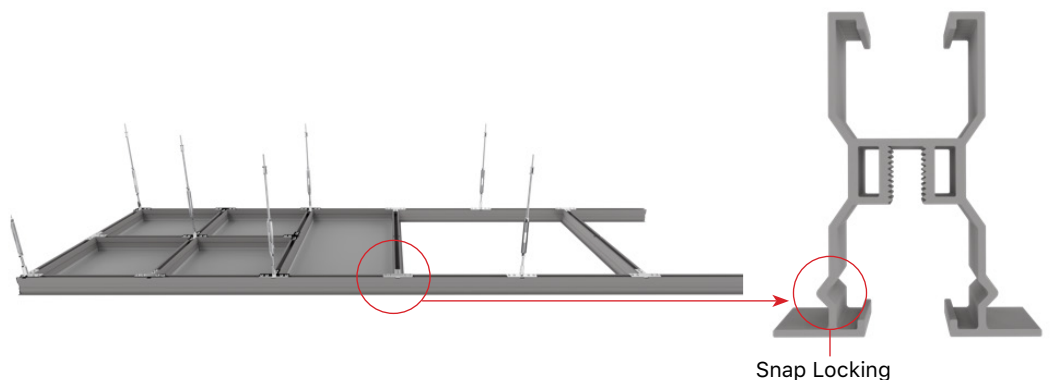

# Fixing to Building Structure

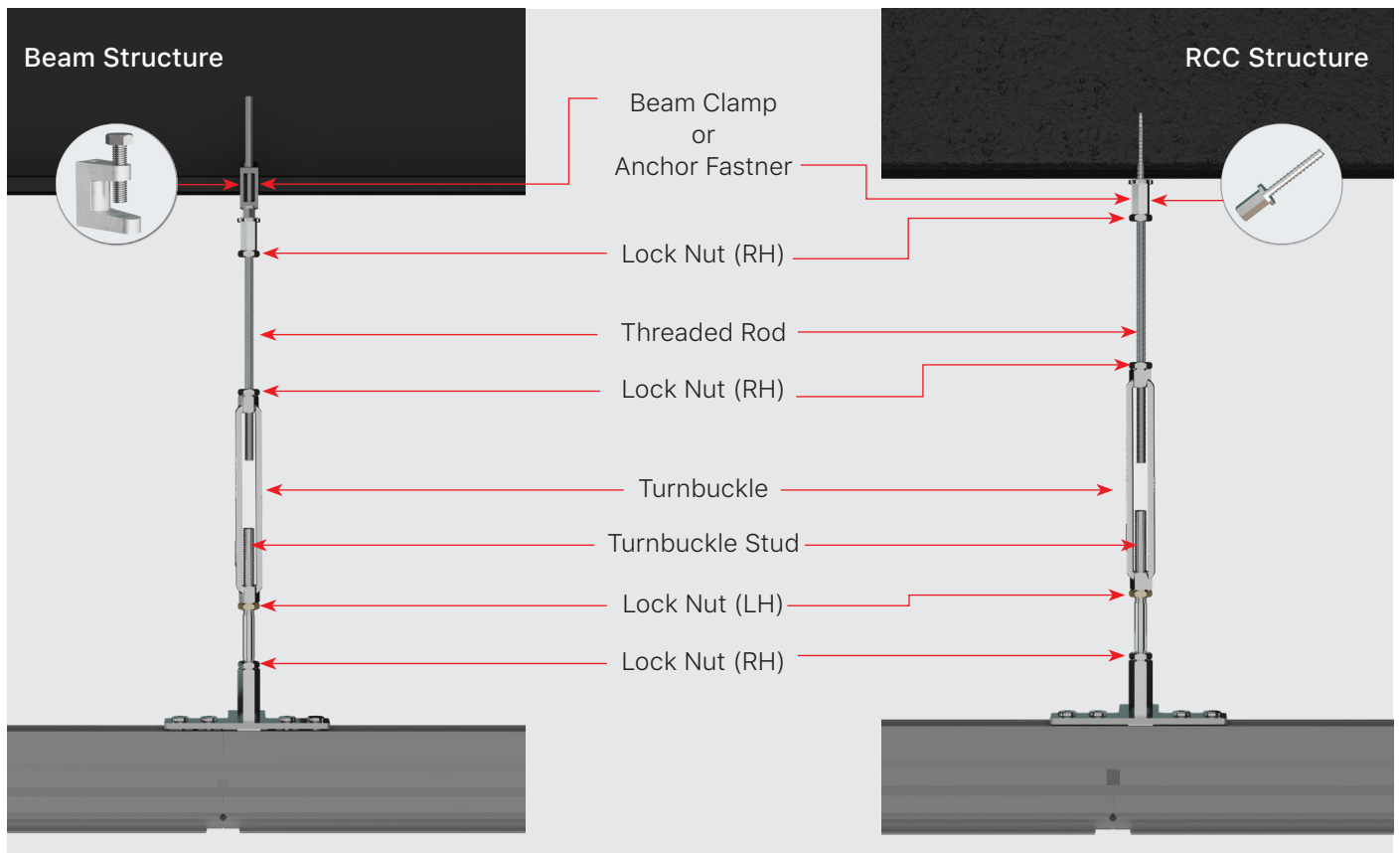

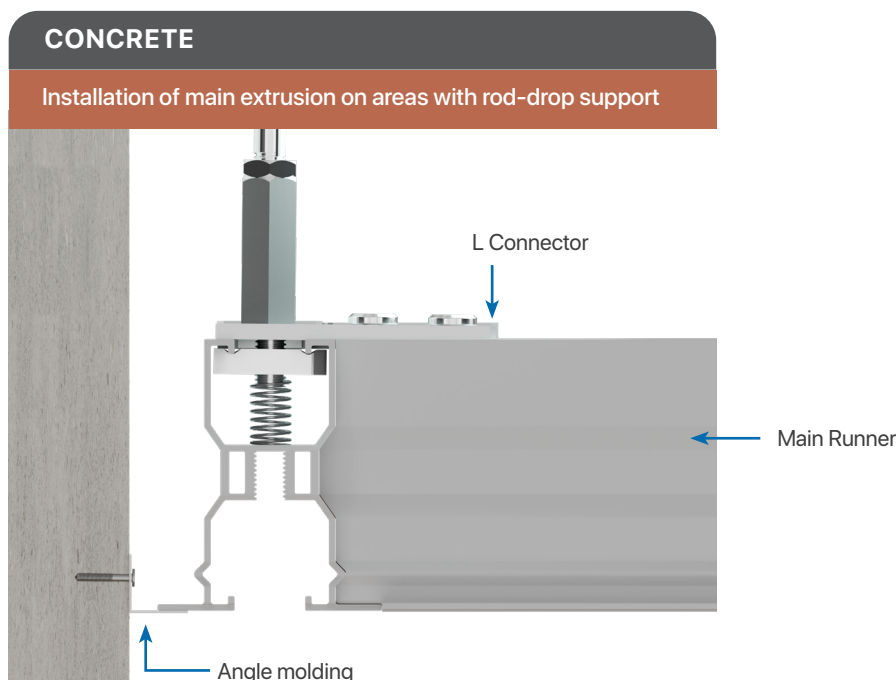

## Installation at perimeter

It is recommended to predrill holes in the perimeter 450mm or a maximum 600mm on center to allow screws to pass through and secure the perimeter to studs or structure. The wall angle can be attached to studs or structures using screws.



# Certifications

## Sustainable Excellence

U-Flex Structural Ceiling Grid Solution is now EPD Certified



\*EN 13501-1:2018  
Class A1



\*EN ISO  
10140-2:2010



\*EN  
12114:2000



\*EN 1090-1:2009 + A1:2011  
EN 1090-2:2018

\*Certifications are currently under declaration and pending final approval.